

# SPECIFICATIONS OF GP-33

## DISPLAY

**Screen Size** 4.3" color LCD  
**Effective Display Area** 95.04 (W) x 53.85 (H) mm  
**Pixel Number** 480 (V) x 272 (H) pixels  
**Display Mode**  
 Plotter, Highway, Steering, Nav Data, Satellite, User Display1, User Display2  
**Memory Capacity**  
 3,000 ship's track points  
 10,000 marks and waypoints with comments  
 100 routes, 30 waypoints/route  
**Alarm**  
 Arrival, Anchor watch, XTE, Speed, WAAS, Time, Trip, Odometer

## GPS/WAAS

**Receiver Type**  
 GPS: Twelve discrete channels, C/A code, all-in-view  
 WAAS receiver: Standard fitted in display unit  
**Receive Frequency** L1 (1575.42 MHz)  
**Time to First Fix** Less than 90 seconds (Cold start)  
**Tracking Velocity** 999.9 knots  
**Geodetic Systems** WGS-84 (and others)

## ACCURACY

GPS: Better than 10 m (2rdms)  
 WAAS: Better than 3 m (2rdms)

## INTERFACE

**Ports**  
 DATA1: CAN bus  
 DATA2: NMEA0183 (ver 2.0, 3.0)  
 DATA3: RS-232C

## Display Unit GP-33

0.72 kg 1.58 lb

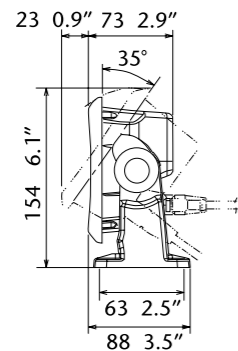
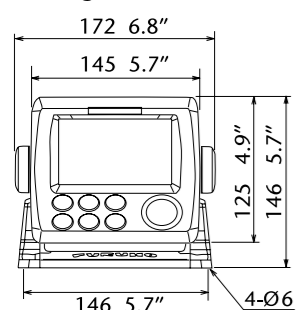

## Flush mount

0.61 kg 1.34 lb

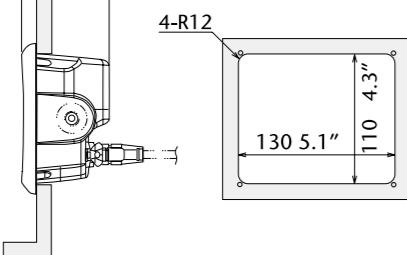
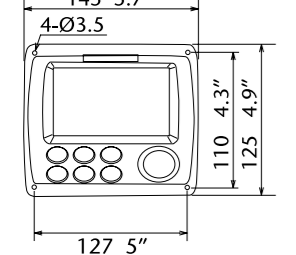

## GPS Antenna GPA-017

0.6 kg 1.3 lb

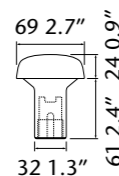

## Output

NMEA0183  
 AAM, APB, BOD, BWC, BWR, DTM, GGA, GLL, GSA, GSV, RMB, RMC, VTG, XTE, ZDA  
**CAN bus**  
 059392, 060928, 061184, 126208, 126464, 126720-1, 126720-2, 126992, 126996, 127258, 129026, 129029, 129033, 129044, 129283, 129284, 129285, 129538, 129539, 129540, 130822, 130823  
**Input**  
**CAN bus**  
 059904, 060928, 061184, 065286, 126208, 126720

## POWER SUPPLY

15 VDC : LEN7 (CAN bus)  
 12-24 VDC : 0.24-0.12 A (Non CAN bus)

## ENVIRONMENT

**Temperature**  
 Display unit: -15°C to +55°C  
 Antenna unit: -25°C to +70°C  
**Waterproofing**  
 Display unit: IP56  
 Antenna unit: IPX6

## EQUIPMENT LIST

### Standard

1. Display unit GP-33 with drop cable 6 m 1 unit
2. Antenna unit GPA-017 with cable 10 m 1 unit
3. Standard spare parts and installation materials

### Option

1. Junction box FI-5002
2. Cable assembly KON-004-02M (NMEA0183) 2 m

## OFFICIAL NAME OF THE EQUIPMENT

GPS Navigator GP-33

## INTERCONNECTION DIAGRAM

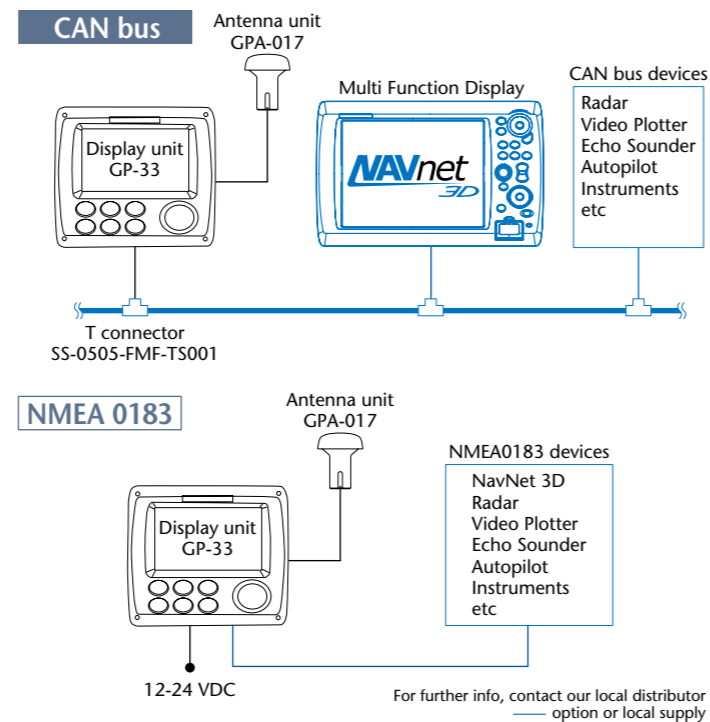

For further info, contact our local distributor  
 — option or local supply

SPECIFICATIONS SUBJECT TO CHANGE WITHOUT NOTICE

All brand and product names are registered trademarks, trademarks or service marks of their respective holders



# FURUNO

# GP-33

## GPS NAVIGATOR



**FURUNO ELECTRIC CO., LTD.**  
 Nishinomiya, Hyogo, Japan  
 www.furuno.co.jp  
**FURUNO U.S.A., INC.**  
 Camas, Washington, U.S.A.  
 www.furunousa.com  
**FURUNO (UK) LIMITED**  
 Havant, Hampshire, U.K.  
 www.furuno.co.uk  
**FURUNO FRANCE S.A.S.**  
 Bordeaux-Mérignac, France  
 www.furuno.fr

**FURUNO ESPAÑA S.A.**  
 Madrid, Spain  
 www.furuno.es  
**FURUNO DANMARK AS**  
 Hvidovre, Denmark  
 www.furuno.dk  
**FURUNO NORGE A/S**  
 Ålesund, Norway  
 www.furuno.no

**FURUNO SVERIGE AB**  
 Västra Frölunda, Sweden  
 www.furuno.se  
**FURUNO FINLAND OY**  
 Espoo, Finland  
 www.furuno.fi  
**FURUNO POLSKA Sp. z o.o.**  
 Gdynia, Poland  
 www.furuno.pl

**FURUNO DEUTSCHLAND GmbH**  
 Rellingen, Germany  
 www.furuno.de  
**FURUNO EURUS LLC**  
 St. Petersburg, Russian Federation  
 www.furuno.com.ru  
**FURUNO HELLAS S.A.**  
 Piraeus, Greece



10025U Printed in Japan  
 Catalogue No. N-871



www.furuno.com

# A smart navigation solution that fits perfect into your console

Compact in size, yet big on features and performance, the FURUNO GP-33 is the perfect GPS navigator for a wide range of vessels. This advanced unit provides accurate and reliable position fixing, thanks to a super sensitive, 12-channel GPS receiver combined with integrated WAAS technology.

The GP-33 has a waterproof display and is built to stand up to tough marine conditions. The durable casing houses an impressive memory, capable of storing up to 3,000 points of ship's track, 10,000 points for marks and waypoints, and 100 routes of up to 30 waypoints each. Vital navigation data is presented on a 4.3" color LCD.

The GP-33 features FURUNO's CAN bus interface system for feeding highly accurate navigation data to your NavNet 3D, radar, chart plotter, autopilot, fish finder or other navigation equipment. The unit offers easy plug-and-play installation with CAN bus network connectivity. NMEA0183 protocol versions are also supported.

- ▶ 4.3" "Sunlight Viewable" color LCD (Brightness: 700 cd)
- ▶ Enhanced data legibility thanks to large characters and high resolution visual aid
- ▶ Stores up to 10,000 marks/waypoints, 100 routes and 3,000 track points
- ▶ 7 display modes available, including 2 user-customized modes
- ▶ Supports both NMEA0183 and CAN bus interface
- ▶ Contact closure capability available on the 10P connector
- ▶ SBAS capable for better measurement

SBAS is a general term for a GPS navigation system with differential correction by means of geostationary satellites. In the US, it is called WAAS (Wide Area Augmentation System), whereas in Europe and Japan, it is called EGNOS (European Geostationary Navigation Overlay System) and MSAS (MSAT Satellite-based Augmentation System), respectively.



## Various Displays

The GP-33 provides navigation data and displays them in a wide variety of numerical and graphical formats. You may freely select which data you want displayed with easy to use controls. The combination of a high resolution screen and large data fields makes the screen easy to read in almost any condition.

### NAV data



The nav data display shows receiver status, position in latitude and longitude (or TDs), course over ground, speed over ground, date and time.

### COG



Easy to read digital compass heading display that greatly assists you in maintaining a desired course.

### Highway

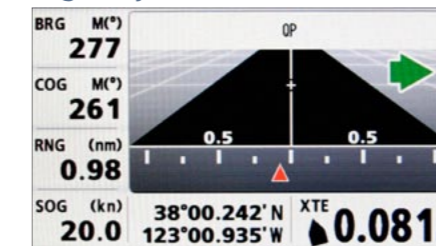

3-D view of own ship's progress toward destination (waypoint). This mode is best used for navigation when a straight line course can be followed.

### User Display



You choose what data is displayed in the User Display Mode.

### Plotter

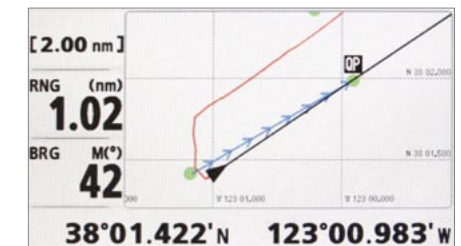

The plotter display traces own ship's track and shows position on a 2-D map\*. This mode presents various data and information with graphic symbols and icons, rather than text. The Auto Waypoint Entry function plots ship's track as "WAYPOINTS". The user may define waypoint entry by time interval, tack angle, etc.

\*The unit does not include charts.

## What is CAN bus?

CAN bus is a communication protocol that shares multiple data and signals through a single backbone cable. You can simply connect any CAN bus devices onto the backbone cable to expand your network onboard. With CAN bus, IDs are assigned to all the devices, and the status of each sensor in the network can be detected. All the CAN bus devices can be incorporated into the NMEA2000 network.



## Easy Operation

Innovative digital graphic displays and intuitive on-screen menu structure provide simple operation and easy access to the features you use most frequently.

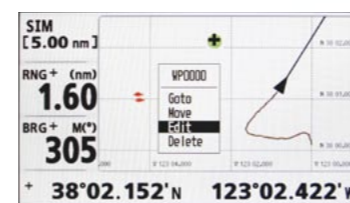

**GP-33**  
GPS NAVIGATOR

